

IRON WORLD TM

Residential, Commercial & Industrial Fencing Solutions

MAVERICK TM ORNAMENTAL IRON

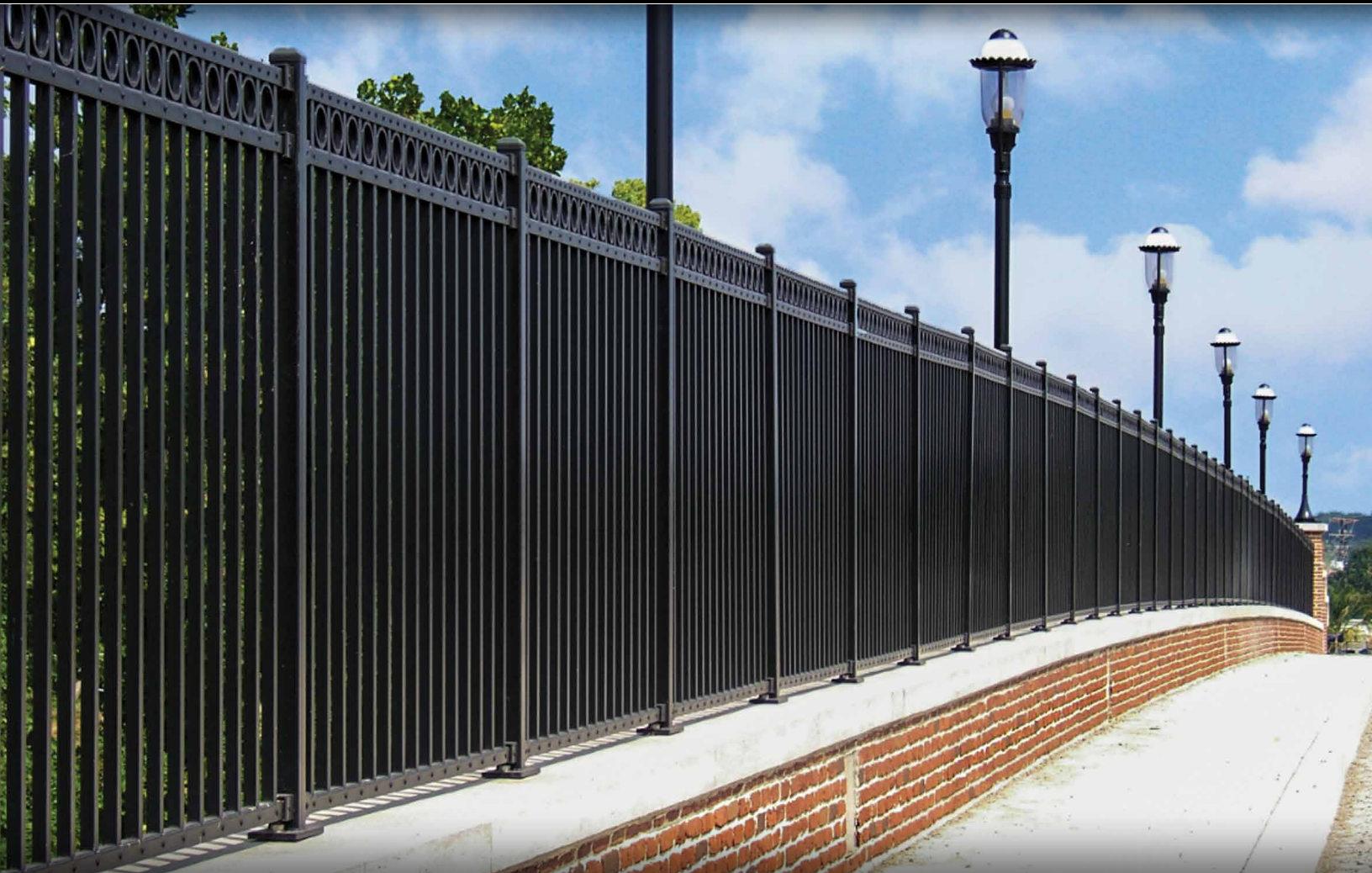

Iron World Manufacturing, LLC, 9390 Davis Avenue, Howard County, Maryland 20723

Phone: 301-776-7448 | Toll Free: 866-310-2747 | Fax: 301-776-7677

ironworldfencing.com



Company Overview

Located in Howard County, Maryland, Iron World is the fastest growing manufacturer and distributor of top-quality ornamental fencing and slide gates in the country. Our world class products meet the highest standards of excellence for design, durability and functionality. You will find our products at such places as the Pentagon, the Washington Monument, the Washington Nationals' Stadium, Norfolk Naval Base, Quantico, New Jersey Devil's Arena, Patriots Stadium and numerous bridges, highways and schools throughout the country.

OUR MISSION

To provide superior products and services at a competitive price. Iron World strives to be at the forefront of ornamental fence fabrication and powder coating technology. Customer service is never sacrificed as we service each and every customer as a partner.

We Stand for Quality

DURABLE COATING

Iron World coats their products using a five stage pre-treatment culminating with a non-chromatic conversion coating to seal the surface and provide additional corrosion protection. Fourteen oscillating, automatic spray guns then apply a polyester powder to the G90 galvanized steel to ensure all parts of the products are evenly reached with a 3.0-3.5 mil thickness of coating. Our products are coated pre-assembly to ensure a smooth, consistent finish that resists cracking, flaking and peeling at the panel's pivot points. This process ensures a full measure of protection in the areas where moisture accumulates and rust begins. Our in-house 1,000 foot powder coating line is equipped to handle fencing and gates that are up to 50 feet in length, 8 feet in height and 27 inches in width. Our quality control team ensures the finished product by following our four step quality control process:

OUR FOUR STEP QUALITY CONTROL PROCESS

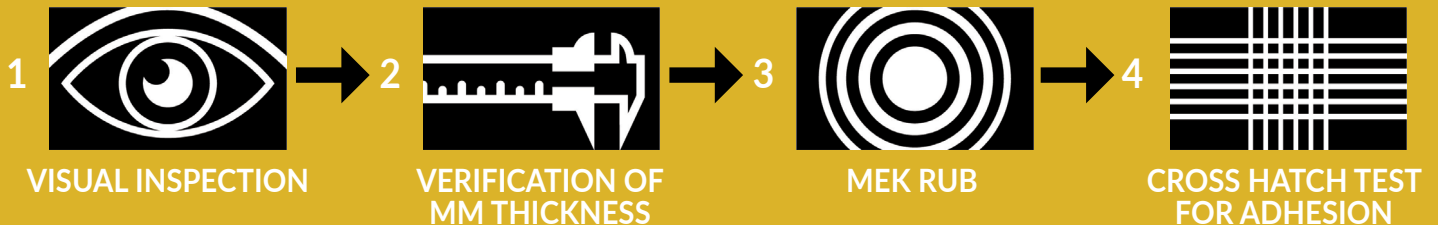

INDUSTRIAL AIRCRAFT RIVETS

To increase panel strength, Industrial Aircraft Rivets, the same product used to build airliners, fasten each picket to the rail giving the system a terrific look with unmatched durability. Fastening each picket to the rails creates an integral structure that provides fixed point loading and spreads any horizontal or vertical force over the entire section. Riveted panels allow damaged pickets to be replaced without scraping the entire panel. Industrial Aircraft Rivets allow you to rack your panels to meet the topography of your job while eliminating the rusting associated with a welded product.

BRACKETS

Standard Bracket: Iron World has transitioned to a tamper proof bolt to add strength, security and ease of installation when fastening your panels to the posts. These brackets come with a top cover to provide a finished look from unsightly rail cuts and short sections. The brackets are open on the bottom to accommodate for installation with uneven grading.

SWIVEL BRACKETS:

Similar to our standard bracket, the swivel bracket also allows the product to swivel up to 45° left and right. These brackets also use the tamper proof bolt, come with a top cover and are open on the bottom.

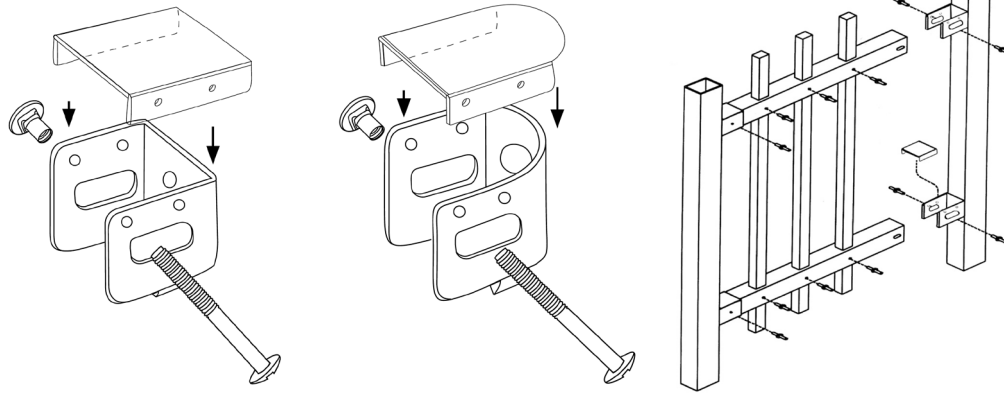

COLORS:

Iron World offers the following standard colors. Unlimited colors available upon request.

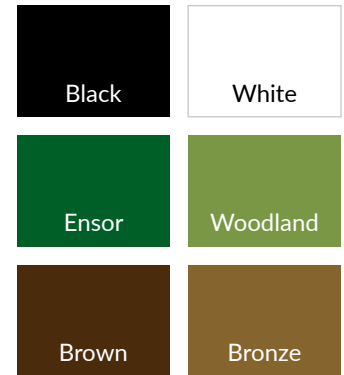

We Focus on Service

Everyone on the Iron World staff is focused on providing the highest quality product and service at a competitive price. No hidden charges, price is complete. We give 24 hour quotes! Two Week lead time! Call Toll-Free at 1-866-310-2747 or Fax us at 301-776-7677.

WARRANTY INFORMATION

Iron World provides a 20 year warranty on all its ornamental fencing. Our cantilever slide gates come with a 15 year warranty. Please visit our website at ironworldfencing.com to print out our warranty information.

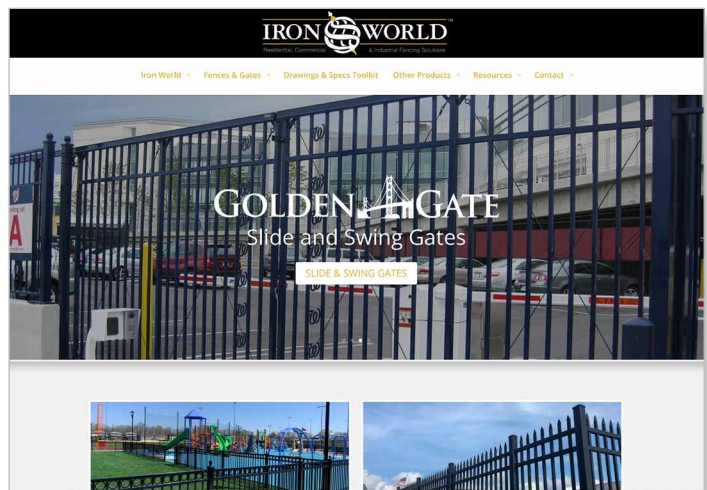
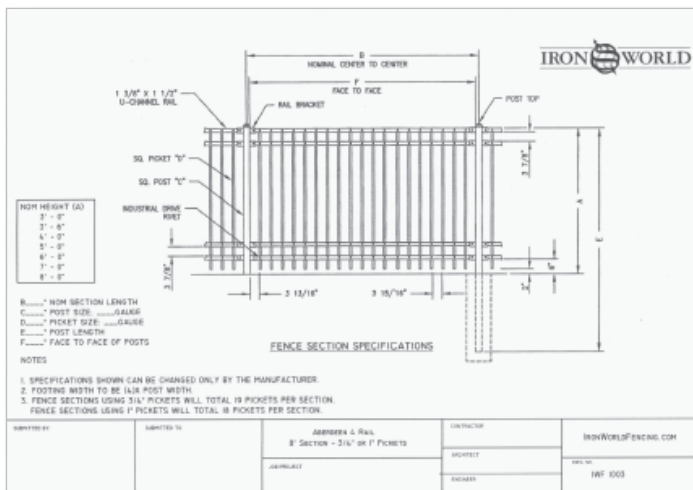

ARCHITECTURAL SPECIFICATIONS

We provide written specifications and CAD drawings for each of our product offerings. We also have an architectural team to assist you with getting the information you need to win and complete the job. Visit our website at ironworldfencing.com for further information.

IRON WORLD WEBSITE

Ironworldfencing.com enables the user to browse our product offering, submit a quote, find product information and drawings, download architectural specifications and see pictures of recent Iron World projects.

MAVERICK™ - I (INDUSTRIAL)

The Maverick - I (Industrial) is our premier iron product utilizing an 11 gauge channel and both 3/4 and 1 inch steel pickets. These pickets are available in 14 gauge, 16 gauge or 18 gauge steel. Industrial Aircraft Rivets are used to attach each individual picket to the rail allowing the section to rack to your job specifications. These rivets provide the strength of a welded product without the rusting that accompanies them. The Maverick - I can rack up to 10 inches on a standard punch channel. The following styles are available in Maverick - I:



ORNAMENTAL IRON PANELS

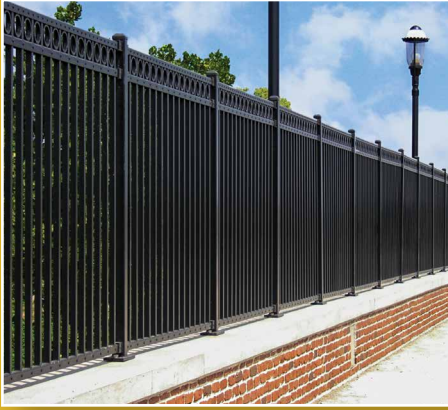

Aberdeen

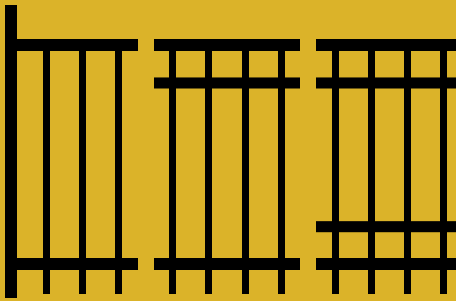

Flat Top
Two, Three, or Four Rails



Barcelona

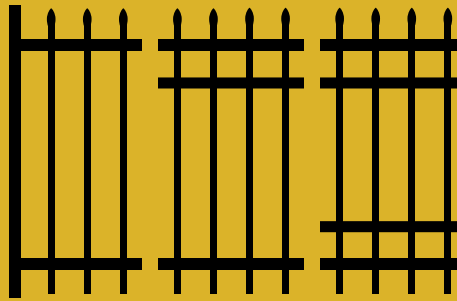

Pointed Top Pickets
Two, Three, or Four Rails



Canterbury

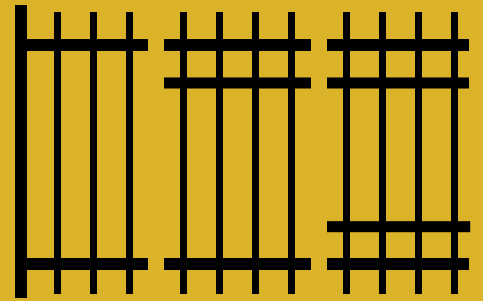

Flat Top Pickets
Two, Three, or Four Rails



Georgetown

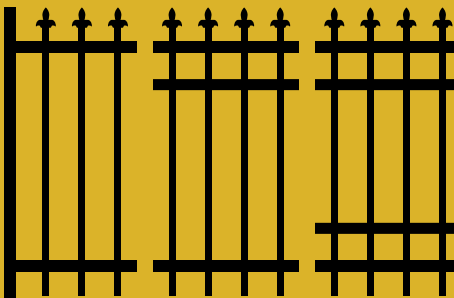

Finial Top Pickets
Two, Three, or Four Rails



Guardian (17°)

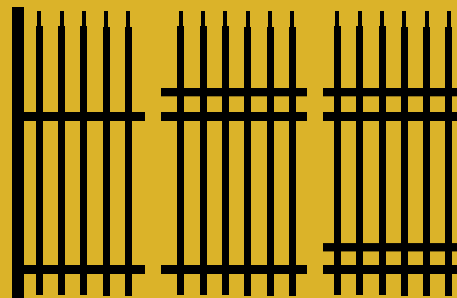

Pointed Top Pickets
Two, Three, or Four Rails



Guardian Plus

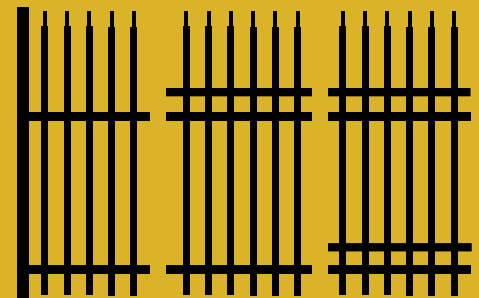

Pointed Top Pickets
Two, Three, or Four Rails

SWING GATES

Iron World offers a complete line of swing gates (walk and double drive) that offer privacy and security in a multitude of styles designed to complement any setting and enhance both commercial and residential properties. Iron World gates are custom made to precisely fit your opening. They can be built using our residential, industrial or standard commercial materials. Swing gates can range in size from 3 foot single gates to 36 foot double gates. Larger sizes are available upon request. We offer all styles with rings, finials and arches.



Iron World manufactures gates in all styles with various accessories and picket tops. Over the next few pages we will show you several examples of single and double swing gates. Call us for more ideas or to create your customized gates.

FINIAL TOPS



Spear



Ball



Fleur-de-lis

PICKET TOPS



Flat



Pointed

INNER CHANNEL OPTION



4" Ring

ABERDEEN SWING GATES

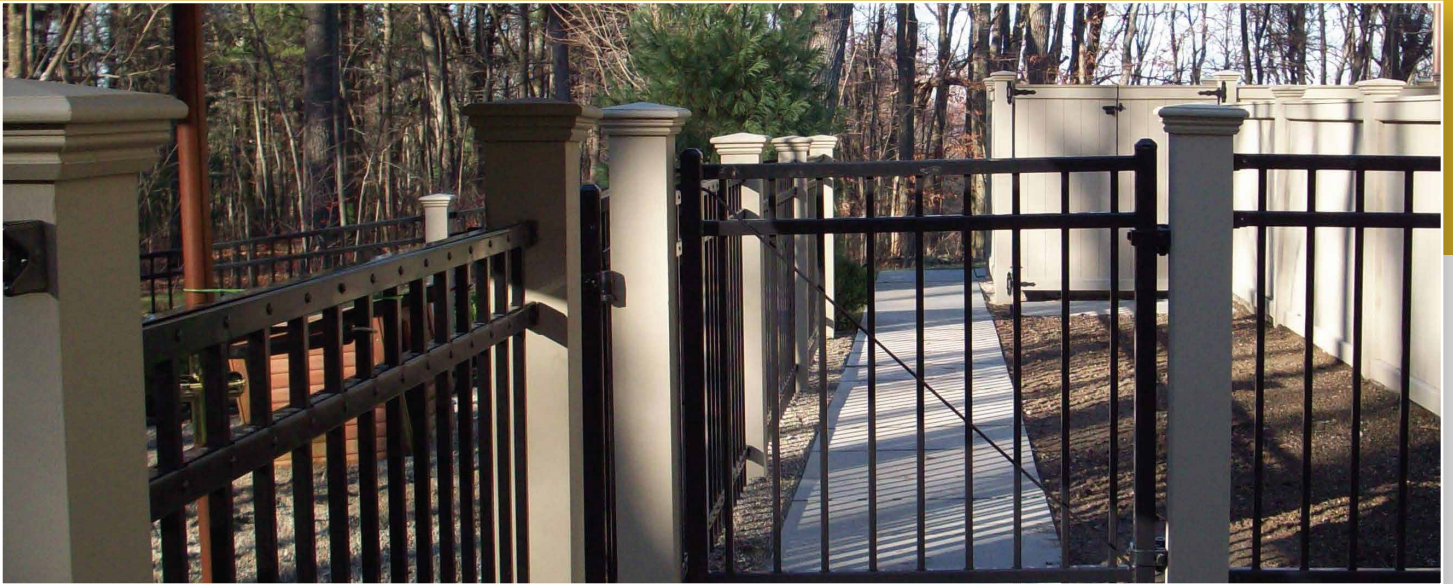

SINGLE SWING

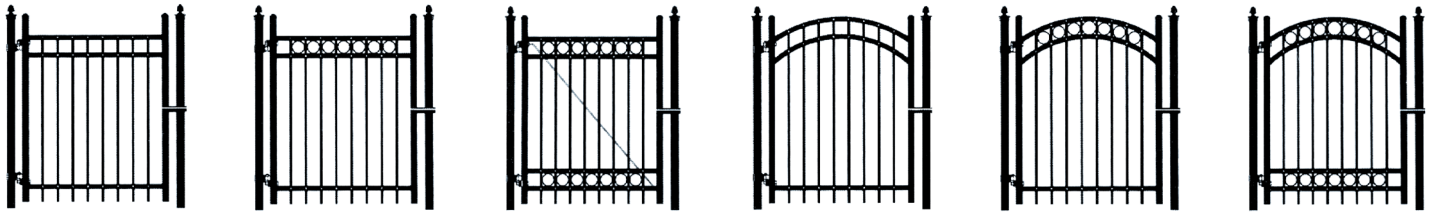

DOUBLE SWING



BARCELONA SWING GATES



SINGLE SWING

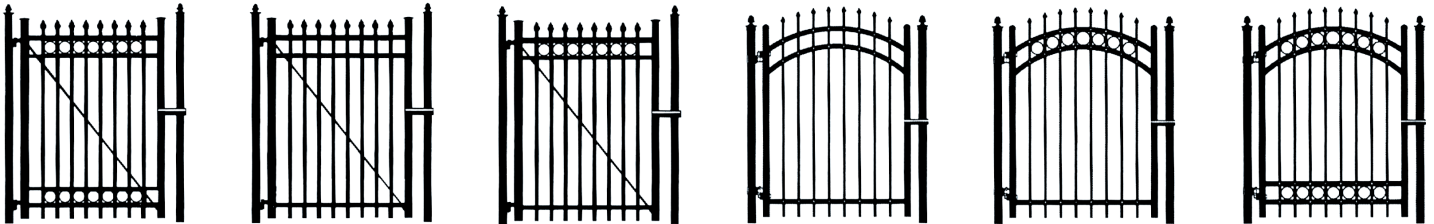

DOUBLE SWING

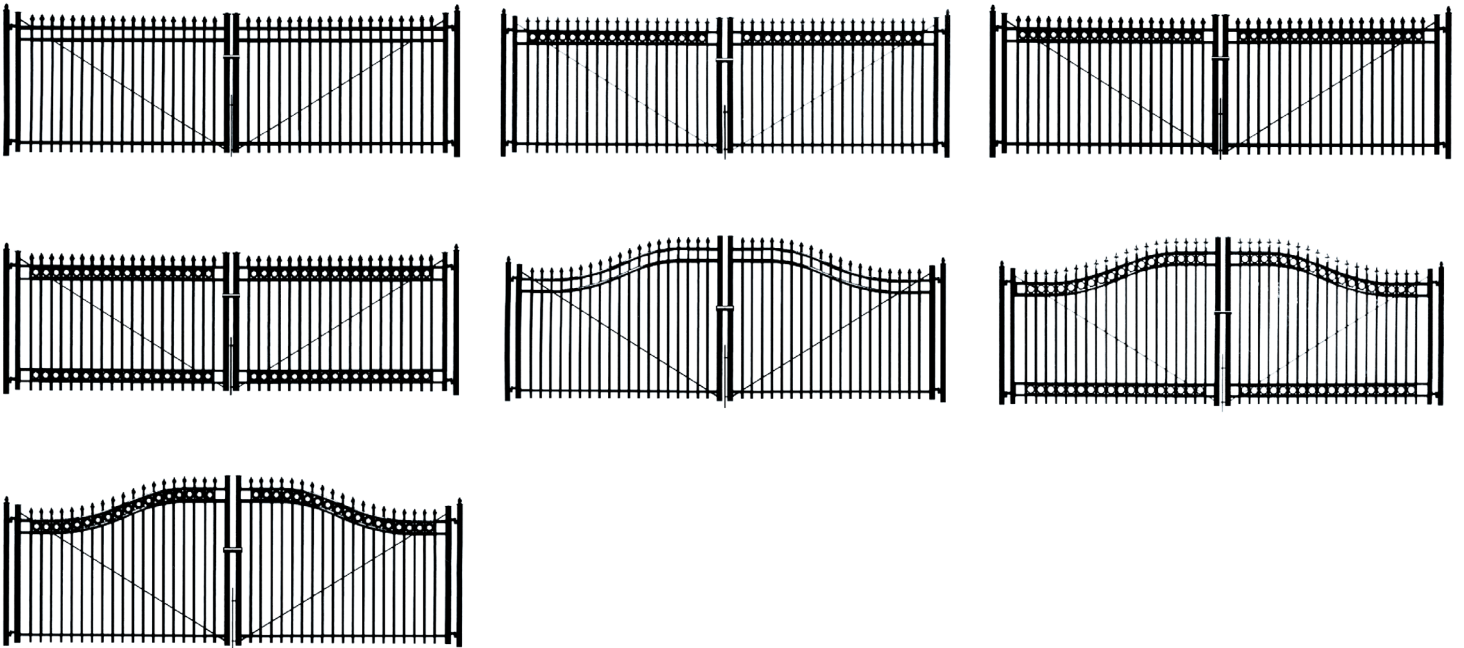

CANTERBURY SWING GATES

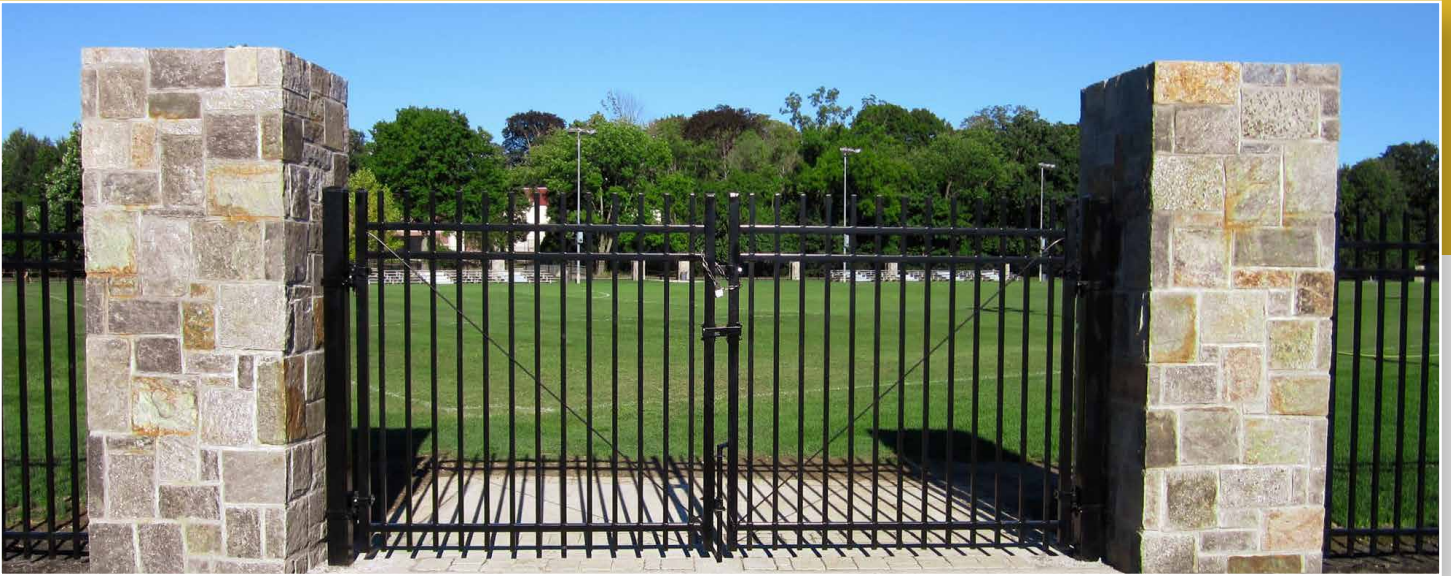

SINGLE SWING

DOUBLE SWING

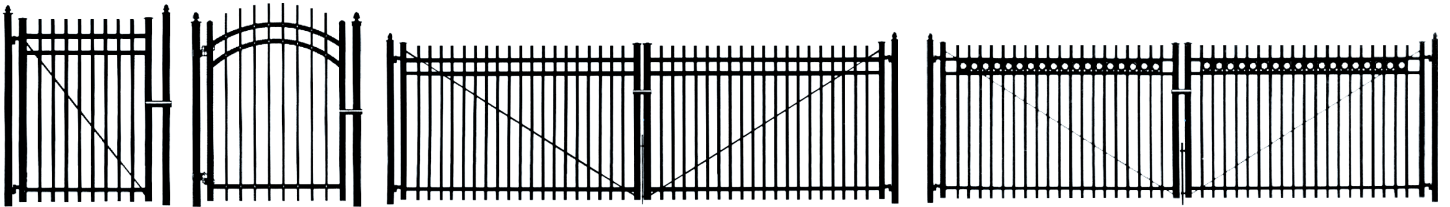

GEORGETOWN SWING GATES



SINGLE SWING

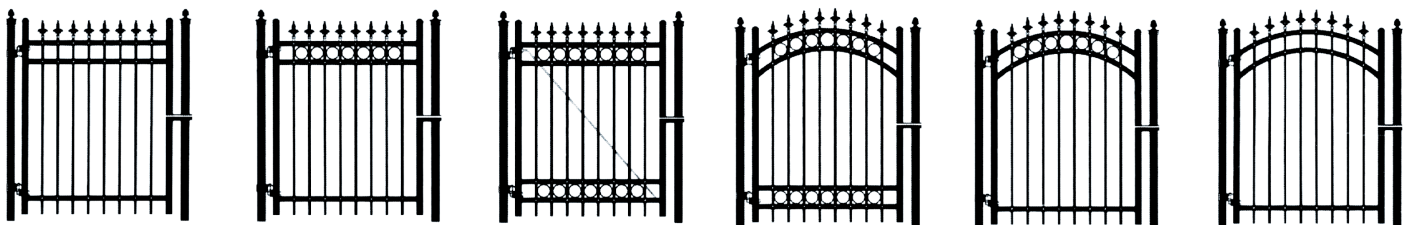

GUARDIAN SWING GATES

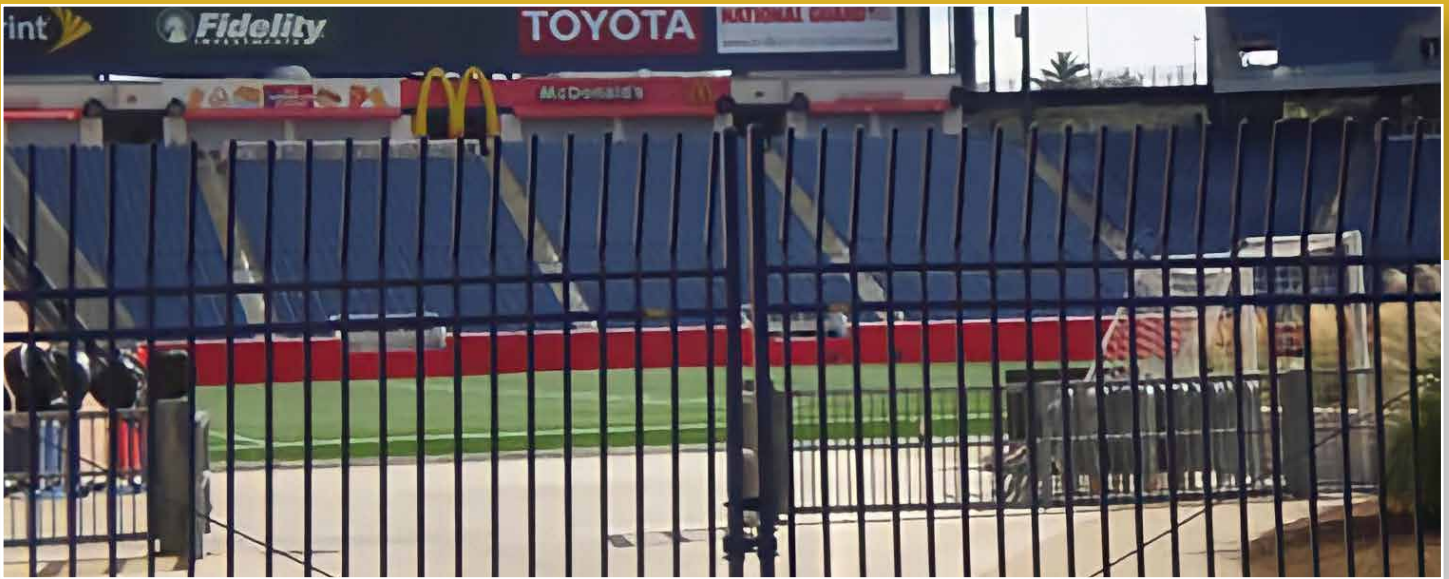

SINGLE SWING

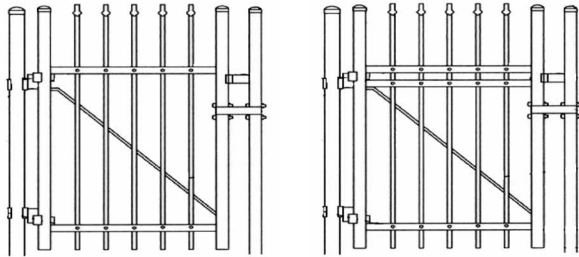

DOUBLE SWING

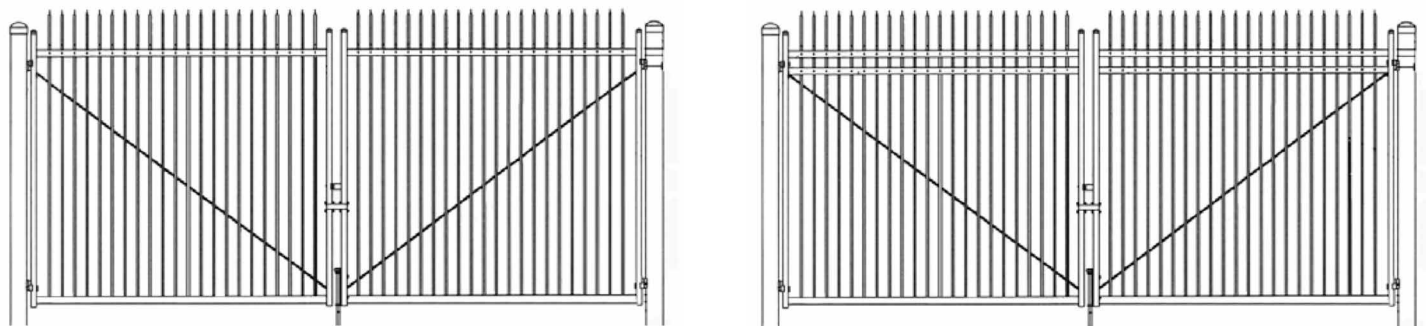

Available Hardware

SWING GATE HARDWARE

Self Closing Hinge	ILD Self Closing
4" Press Steel Hinge	Fulcrum latch 2.5 galv
Barrel Hinges	Fulcrum latch 3 galv
Pilaster Hinges	Fulcrum latch 4 galv
2.5" Black Hinge	Fulcrum latch 2.5 black
3" Black Hinge	Fulcrum latch 3 black
4" Black Hinge	Fulcrum latch 4 black
6" Black Hinge	4" Cantilever latch
Top Pull Latch	6 5/8" Cantilever latch

SLIDE GATE HARDWARE

4" Truck bracket	Blank channel
6 5/8" Truck bracket	2"sq. Gate stops
Truck assembly - 4 wheel	4" Lower guide
Truck assembly - 8 wheel	Lock box
Alum 2x2	Drop Rod
Splice kit	

ORNAMENTAL IRON ACCESSORIES

Swivel brackets
Press steel bracket
Press steel bracket w/o cover
Self tapping bracket bolts
6x6 post plate
8x8 post plate

POST ACCESSORIES

2" flat cap	2" ball cap
2.5" flat cap	2.5" ball cap
3" flat cap	3" ball cap
4" flat cap	4" ball cap
6" flat cap	6" ball cap

Polyester Coated Post

Post Size	2"	2½"	3"	4"	6"	8"
Gauge(s)	14 & 16g	14 & 16g	12g	11g	3/16" wall	1/4" wall

PRE-HUNG GATES



PANIC GATES



GOLDEN GATE™

CHAIN LINK & ORNAMENTAL SLIDE GATES

Iron World Manufacturing prides itself on producing the BEST slide gates in the industry. With our Golden Gate Series, you get the most up-to-date construction features backed by Iron World's quality reputation for craftsmanship, competitive pricing, short lead times and reasonable shipping. Slide Gates are available in aluminum chain link slider or ornamental powder coated slider. Features include a closed track system with lubricated eight bearing rollers to protect from the elements and guarantee smooth opening and closing.



Ornamental Slide Gates



Chain Link Slide Gates



Polyester Slide Gates



Iron World Manufacturing, LLC
9390 Davis Avenue
Howard County, Maryland 20723

Phone: 301-776-7448
Toll Free: 866-310-2747
Fax: 301-776-7677

ironworldfencing.com

