



**FENCE TRAC**

**VERSATILE FENCING SOLUTIONS**

**Premium | Stylish | Long-Lasting**

# ABOUT US

---

FenceTrac® is the premium choice for privacy fencing. With endless combinations for filler materials, it's patented fencing design standard will please any style. FenceTrac® kits are designed for tongue and groove, wood, PVC, composite and much more!

FenceTrac® is versatile and stylish. Our unique patented fencing system offers residential and commercial property owners the ability to use nearly any type of infill. The possibilities are endless. Our 20-year warranty ensures your fence will last for years to come.



THE ***FUTURE***  
OF FENCING

For many years, fence customers who have purchased traditional privacy fencing have been frustrated with the inevitable maintenance needs and repairs. FenceTrac® has solved this problem by creating a steel trac system of the highest quality. Your privacy materials are now protected and strengthened. This is the future of fencing!

---

**Premium | Stylish | Long-Lasting**

---

**PREMIUM**  
**STYLISH**  
**LONG-LASTING**

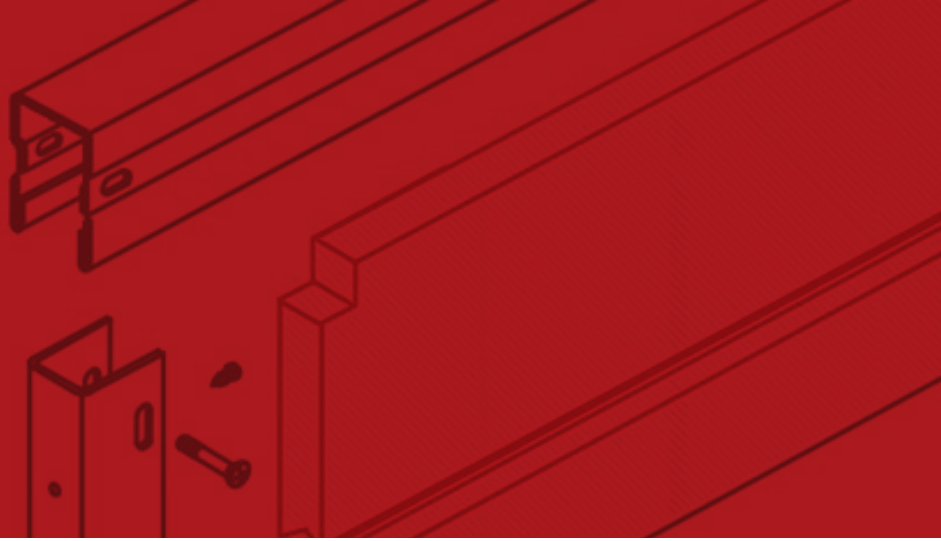

## **PATENTED U-CHANNEL RAILS**

The FenceTrac system creates a secure and durable fence that accommodates nearly any infill materials.

## **THE LOOK YOU WANT**

Insert your choice of infill – Wood, Composite PVC, Metal, Welded Wire, Vinyl, or Bamboo – In vertical or horizontal orientation to create the exact look you want.

## **RESIDENTIAL & COMMERCIAL FENCING**

FenceTrac works equally well to provide secure and beautiful fencing in both residential and commercial environments.

## **OUR MISSION**

To create a truly one-of-a-kind fence that matches the look and style of your property, and lasts years longer than a traditional wooden fence.



# PROJECT PORTFOLIO

---

FenceTrac is designed to be used with nearly any type of rigid infill, so you can create the exact look you want. We offer several standard infill choices, including maintenance-free composite. Simple & fast assembly. Infill materials slide into U-shaped FenceTrac rails. No need for hundreds of nails or screws.

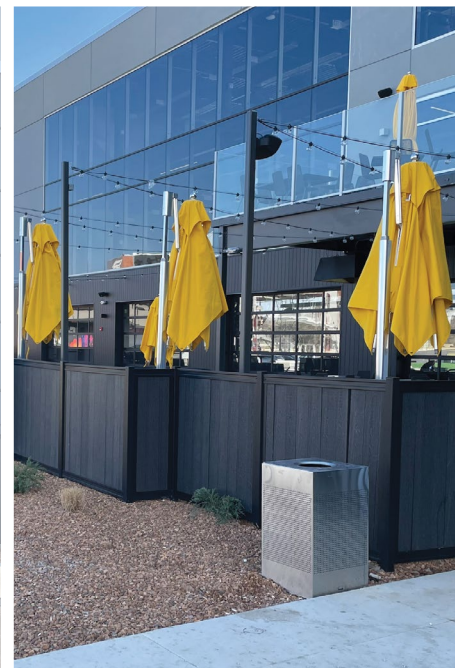
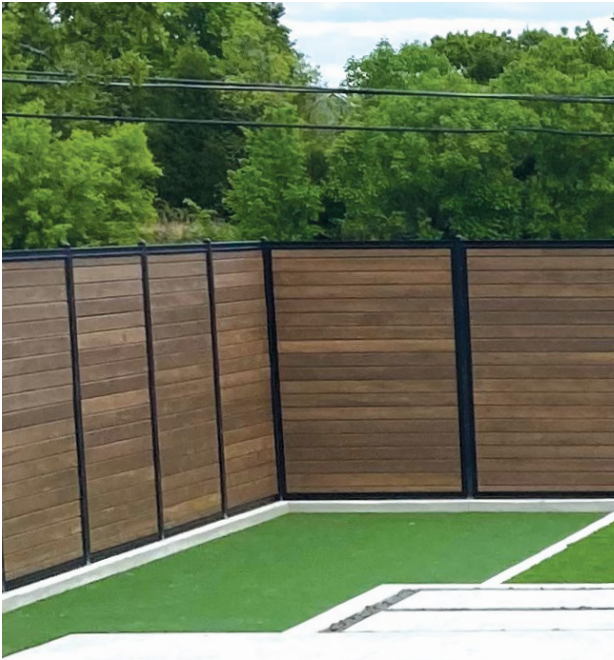

---

Premium | Stylish | Long-Lasting



ENDLESS  
***POSSIBILITIES***



# WHY CHOOSE US?

---

For years, property owners who purchased traditional privacy fencing have been frustrated by rusty nails, cracked & rotting wood and other unavoidable maintenance issues that come with owning a standard wooden fence. And nearly every privacy fence looks just like the one next door. **FenceTrac is different.**

## Thousands

of customers have already trusted us.

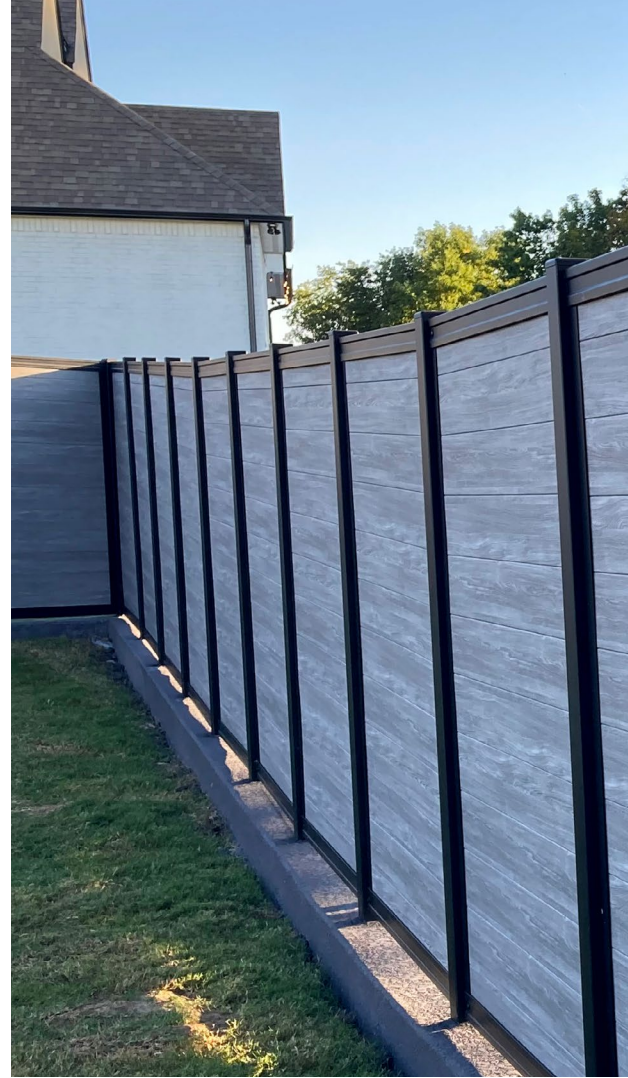

## ADVANTAGES

---

### ✓ **20-YEAR LIMITED WARRANTY**

FenceTrac has a much longer lifespan (with lower lifetime cost) than traditional wood or vinyl fencing.

### ✓ **PREMIUM QUALITY, PROUDLY MADE IN AMERICA**

FenceTrac proudly made in America. It's easy to assemble, easy to maintain and easy to customize.

### ✓ **STRENGTH & DURABILITY**

FenceTrac creates a stronger fence that provides more privacy and more security.

### ✓ **VERSATILE & STYLISH**

FenceTrac provides an unlimited array of options for looks, style and design and looks fantastic in both residential and commercial properties.



## BUILD YOUR ***DREAM FENCE***

“We love selling the FenceTrac system to our customers. They are always excited to have a fence made to last a long time with a beautiful look on both sides.”

– Ranchers Pipe and Steel

---

“We’ve used the FenceTrac System for several of our housing developments. The clean look is perfect for perimeter fencing and entrances. Because the frame and post are metal, they will last for many years to come.”

– Dodson & Associates

# DESIGN



Superior coating solutions for the peace of mind that buying American products should bring.

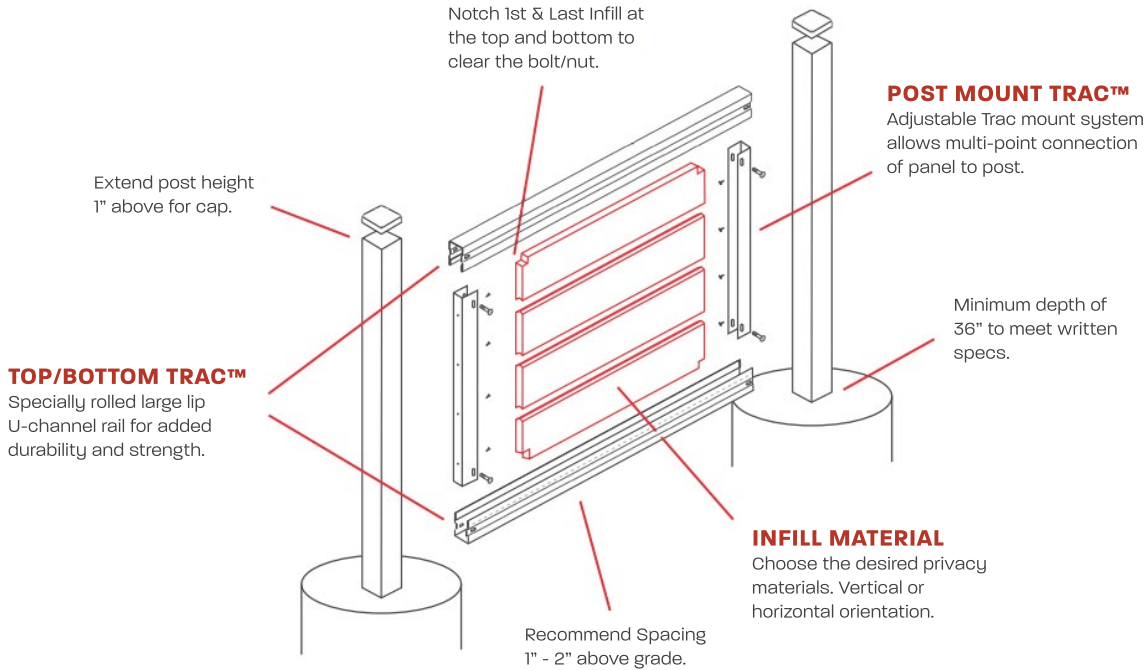

## STANDARD COLOR



## OTHER COLORS

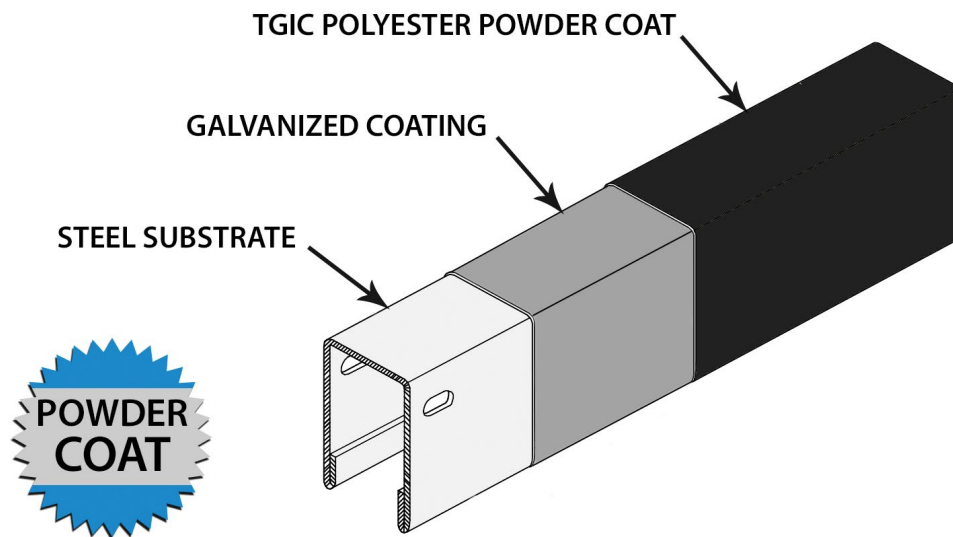

Premium | Stylish | Long-Lasting



# SPECS

## MINIMUM SIZES FOR FENCETRAC POSTS

FENCE POSTS (STEEL)	PANEL HEIGHT
2-1/2" x 14 Ga.	Up to & Including 6' Height for Residential Applications
2-1/2" x 12 Ga.	Up to & Including 8' Height for Residential Applications
3" x 12 Ga.	Up to & Including 8' Height for Residential & Commercial Applications
4" x 11 Ga.	Up to & Including 10' Height for Residential & Commercial Applications

GATE LEAF	GATE HEIGHT		
	Up to & including 6'	Over 6' Up to & Including 8'	Over 8' Up to & Including 10'
Up to 4'	2-1/2" x 14 Ga.	3" x 12 Ga.	4" x 11 Ga.
4'1" TO 6'	3" x 12 Ga.	3" x 12 Ga.	4" x 11 Ga.
4'1" TO 6'	4" x 11 Ga.	4" x 11 Ga.	6" X 3/16"

## COATING PERFORMANCE REQUIREMENTS

QUALITY CHARACTERISTICS	ASTM TEST METHOD	PERFORMANCE REQUIREMENTS
Adhesion	D3359 – Method B	Adhesion (Retention of Coating) over 90% of test area (Tape and knife test).
Corrosion Resistance	B117, D714 & D1654	Corrosion Resistance minimum 1,000 hours (Scribed per D1654; failure mode is accumulation of 1/8" coating loss from scribe or medium #8 blisters).
Impact Resistance	D2794	Impact Resistance over 60 inch lb. (Forward impact using 0.625" ball).
Weathering Resistance	D822 D2244, D523 (60° Method)	Weathering Resistance over 1,000 hours (Failure mode is 60% loss of gloss or color variance of more than 3 delta-E color units).

## CONSTRUCTION SPECIFICATION SECTION 32 31 00

### PART 1 - GENERAL

#### 1.01 WORK INCLUDED

The contractor shall provide all labor, materials and appurtenances necessary for installation of the privacy metal fence system defined herein at (specify project site).

#### 1.02 RELATED WORK

Section \_\_\_ - Earthwork

Section \_\_\_ - Concrete

#### 1.03 SYSTEM DESCRIPTION

The manufacturer shall supply a steel framework Trac system design manufactured by FenceTrac™. The system shall include all components (i.e., all necessary Trac components, posts, gates and hardware) required. Privacy filler materials will be supplied by (specify manufacturer or distributor of specific filler option).

#### 1.04 QUALITY ASSURANCE

The contractor shall provide laborers and supervisors who are thoroughly familiar with the type of construction involved and materials and techniques specified.

#### 1.05 REFERENCES

- ASTM A653/A653M - Standard Specification for Steel Sheet, Zinc-Coated (Galvanized) or Zinc-Iron Alloy Coated (Galvannealed) by the Hot-Dip Process.
- ASTM B117 - Practice for Operating Salt-Spray (Fog) Apparatus.
- ASTM D523 - Test Method for Specular Gloss.
- ASTM D714 - Test Method for Evaluating Degree of Blistering in Paint.
- ASTM D822 - Practice for Conducting Tests on Paint and Related Coatings and Materials using Filtered Open-Flame Carbon-Arc Light and Water Exposure • Apparatus.
- ASTM D1654 - Test Method for Evaluation of Painted or Coated Specimens Subjected to Corrosive Environments.
- ASTM D2244 - Test Method for Calculation of Color Differences from Instrumentally Measured Color Coordinates.
- ASTM D2794 - Test Method for Resistance of Organic Coatings to the Effects of Rapid Deformation (Impact).
- ASTM D3359 - Test Method for Measuring Adhesion by Tape Test.

#### 1.06 SUBMITTAL

The manufacturer's submittal package shall be provided prior to installation.

#### 1.07 PRODUCT HANDLING AND STORAGE

Upon receipt at the job site, all materials shall be checked to ensure that no damages occurred during shipping or handling. Materials shall be stored in such a manner to ensure proper ventilation and drainage, and to protect against damage, weather, vandalism and theft.

### PART 2 - MATERIALS

#### 2.01 MANUFACTURER

The commercial ornamental steel fence system shall conform to FenceTrac standard system with (specify filler materials for privacy function – i.e. Wood, Composite Board, Vinyl, Welded Wire, etc.) style filler materials supplied by (specify manufacturer or distributor of specific filler option). FenceTrac is manufactured in Tulsa, OK. Contact: 918-794-8722; info@fencetrac.com.

#### 2.02 MATERIAL

A. Steel material for fence framework, when galvanized prior to forming, shall conform to the requirements of ASTM A924/A924M, with a minimum yield strength of 45,000 psi (310 MPa). The steel shall be hot-dip galvanized to meet the requirements of ASTM A653/A653M with a minimum zinc coating weight of 0.90 oz/ft<sup>2</sup> (275 g/m<sup>2</sup>), Coating Designation G-90.

B. Steel material for posts, when galvanized prior to forming, shall conform to the requirements of ASTM A924/A924M, with a minimum yield strength of 45,000 psi (310 MPa). The steel shall be hot-dip galvanized to meet the requirements of ASTM A653/A653M with a minimum zinc coating weight of 0.60 oz/ft<sup>2</sup>(183 g/m<sup>2</sup>), Coating Designation G-60.

### PART 2 - MATERIALS (continued)

C. Material for the Top and Bottom Tracs shall be 18 Ga. steel. Material for the Post Mount and Vertical-H Tracs shall be 18 Ga. steel. The cross-sectional shape of the rails shall conform to the manufacturer's roll-formed U-channel design. Fence posts and gate posts shall meet the minimum size requirements of Table 1.

#### 2.03 FABRICATION

A. All fence framework shall be pre-cut to specified lengths. The Post Mount Tracs shall be pre-drilled for attachment to the posts.

B. The manufactured steel framework and posts shall be subjected to a multi-stage pretreatment cleaning and coating process. Starting with the pre-rinse and wash process for good adhesion, followed by oven drying in preparation for powder coat application, then adding an electrostatic spray application of a thermosetting Polyester-TGIC powder coat finish. The total coating shall be a minimum thickness of 3 mils (0.0762mm). The color shall be (specify Black, Bronze, White or Beige). The coated framework shall be capable of meeting the performance requirements for each quality characteristic shown in Table 2.

C. Completed sections shall be capable of supporting appropriate wind speeds according to ASCE 7-05 for Commercial/Industrial designed systems only. Residential applications will vary and wind speed testing can be calculated for an additional cost if necessary. Panels without special ornamentation or custom additions on top shall be biasable up to a 45% change in grade.

### PART 3 - EXECUTION

#### 3.01 PREPARATION

All new installation shall be laid out by the contractor in accordance with the construction plans.

#### 3.02 FENCE INSTALLATION

Fence post shall be spaced according to FenceTrac installation instructions or Submittal drawings. For installations that must be raked to follow sloping grades, the post spacing dimension must be measured along the grade. Fence sections shall be attached to posts with self-tapping screws supplied by the manufacturer. Posts shall be set in concrete footers having a minimum depth of 36" (Note: In some cases, local restrictions of freezing weather conditions may require a greater depth). The "Earthwork" and "Concrete" sections of this specification shall govern material requirements for the concrete footer. Posts setting by other methods such as plated posts or grouted core-drilled footers are permissible only if shown by engineering analysis to be sufficient in strength for the intended application. Alternative materials on posts are also possible with the FenceTrac system, additional contact may be necessary to complete special post installations.

#### 3.03 FENCE INSTALLATION MAINTENANCE

When cutting/drilling rails or posts adhere to the following steps to seal the exposed steel surfaces; 1) remove all metal shavings from cut area. 2) Apply zinc-rich primer to thoroughly cover cut edge and/or drilled hole; let dry. 3) Apply 2 coats of custom finish paint matching fence color. Failure to seal exposed surfaces per steps 1-3 above will negate warranty. FenceTrac spray cans or paint pens shall be used to prime and finish exposed surfaces; it is recommended that paint pens be used to prevent overspray. Use of non-FenceTrac parts or components will negate the manufacturer's warranty.

#### 3.04 GATE INSTALLATION

Gate posts shall be spaced according to the manufacturer's gate drawings, dependent on standard out-to-out gate leaf dimensions and gate hardware selected. Type and quantity of gate hinges shall be based on the application; weight, height, and number of gate cycles. The manufacturer's gate drawings shall identify the necessary gate hardware required for the application. Gate hardware shall be provided by the manufacture of the gate and shall be installed per manufacturer's recommendations.

#### 3.05 CLEANING

The contractor shall clean the jobsite of excess materials; post-hole excavations shall be scattered uniformly away from posts.



## FENCETRAC 20 YEAR LIMITED WARRANTY

FenceTrac® Customizable Privacy Metal Fencing System is manufactured from the highest quality materials by craftsmen to meet the highest standards of workmanship in the industry. Hot-Dipped galvanized steel is precisely heated to provide a Galvanealed substrate layer of protection. Topcoat consists of electrostatic spray application of a thermosetting Polyester-TGIC powder coat finish, which provides the protection necessary to withstand adverse environmental conditions.



The powder coated surface on all framework (i.e., Top Trac, Bottom Trac, Post Mount Trac) by FENCETRAC® is guaranteed under normal and proper usage, against chipping, cracking, peeling, blistering or corroding for a period of twenty (20) years from the original purchase date. Normal and proper usage does not include physical damage, abrasion or exposure to salty environments to the protective coating.

FENCETRAC® Customizable Privacy Metal Fencing System framework is also guaranteed for the same period of time against defects in workmanship or materials.

Should any portion of FENCETRAC® framework manufactured by FENCETRAC® fail in accordance with any of the above conditions, FENCETRAC® warrants to the original purchaser their redemption through replacement, renewal or issuance of a pro-rated credit. The decision as to which method of redemption is allowed is solely at the discretion of FENCETRAC®. If pro-rated allowance is the chosen alternative, the amount will be based on the total number of years under warranty from the date of purchase to the date of claim, based on the original cost of materials found to be defective. This warranty is specifically and intentionally provided only for the FENCETRAC® framework system and not any additional third party additions, ornaments or filler materials. Notice of failure under the conditions of this warranty shall be sent to FENCETRAC® or its authorized representative, in writing, together with proof of purchase and shall specify the nature of the defect and when it was first observed. Should the fence be improperly installed, FENCETRAC® shall not be responsible for guaranteed performance or appearance in material. Neither does this guarantee apply when failure or damage is due to improper use or application, abuse or misuse, salty environments, vandalism or acts of God. FENCETRAC® reserves the right to inspect the material to determine validity of the claim

Upon validation of the claim by FENCETRAC® or its authorized representative, redemption by replacement, renewal or issuance of a pro-rated credit shall be made by FENCETRAC®. Reimbursement for the costs of removal and installation of materials are not included in the guarantee, nor will FENCETRAC® provide those services.

The above constitutes the complete warranty by the manufacturer. No other agreement, written or implied, is valid. FENCETRAC® does not authorize any other person or agent to make any other express warranties. Some jurisdictions do not allow limitations on how long an implied warranty lasts, nor do they allow for an exclusion or limitation of incidental or consequential damages; therefore, limitations and exclusions noted herein may not apply.

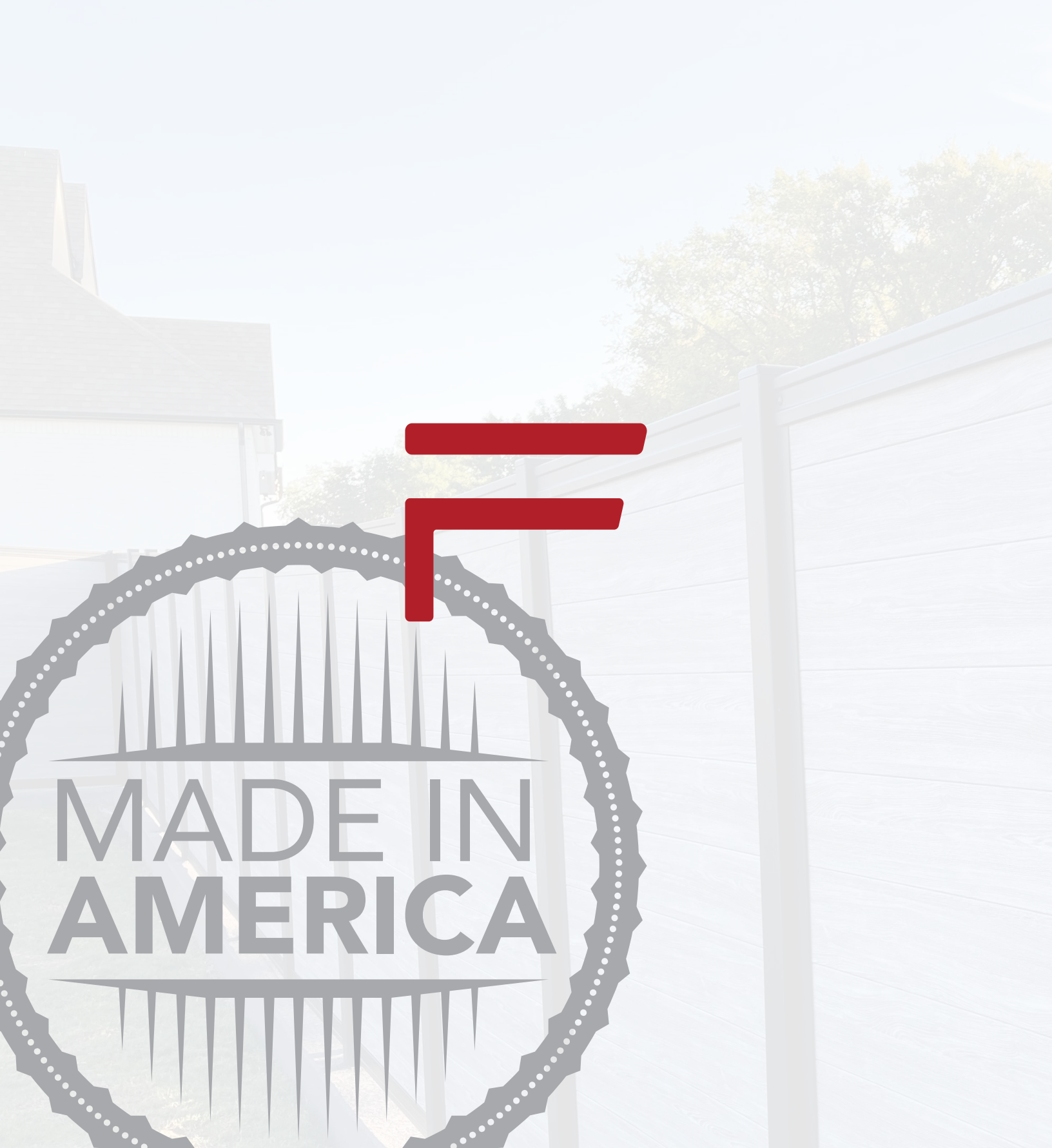

**MADE IN  
AMERICA**



**FENCE TRAC**

918.794.8722

FENCETRAC.COM