

# Echelon Plus<sup>®</sup>



[AMERISTARFENCE.COM](http://AMERISTARFENCE.COM) | 888-333-3422

ASSA ABLOY, the global leader in door opening solutions

**AMERISTAR<sup>®</sup>**

**ASSA ABLOY**

# Echelon Plus<sup>®</sup>

.75"sq x .045" wall PICKETS | 1.4375" x 1.25" x (.090" side / .060" top) ForeRunner™ RAILS  
2.5"sq x .060" POSTS w/reinforced internal web



***Echelon Plus has taken the quality and performance of aluminum ornamental fencing to a higher level.***

Today, the damage potential that threatens fences has increased significantly in probability and destructive force. Echelon Plus is ***designed with the long-term durability to withstand rigorous environments.***

The cross-section of the Echelon Plus rail is reinforced with an ***internal web*** that significantly increases strength, particularly against ***forces acting horizontally.*** This added strength, coupled with an improved post design, powder-coated finish, and fully welded gates, ***guarantees years of maintenance-free service and value.***

## THE ECHELON PLUS DIFFERENCE

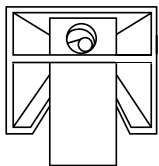

### **Echelon ForeRunner<sup>®</sup>** ***Internal Locking System***

- ▶ Internal rod is tamper proof and pickets cannot be removed
- ▶ Retainer rod is hidden and rail has a “good neighbor” appearance
- ▶ Retainer goes through two walls of picket, yielding twice the support

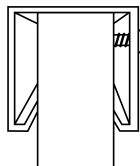

### **Competitors U-Channel** ***Removable Tek Screws***

- ▶ Picket attachment can easily be compromised with simple tools
- ▶ Exposed Tek screw detracts from a smooth architectural profile
- ▶ Tip of Tek screw barely engages one wall of picket

# NO RIVETS. NO SCREWS. NO WELDS.

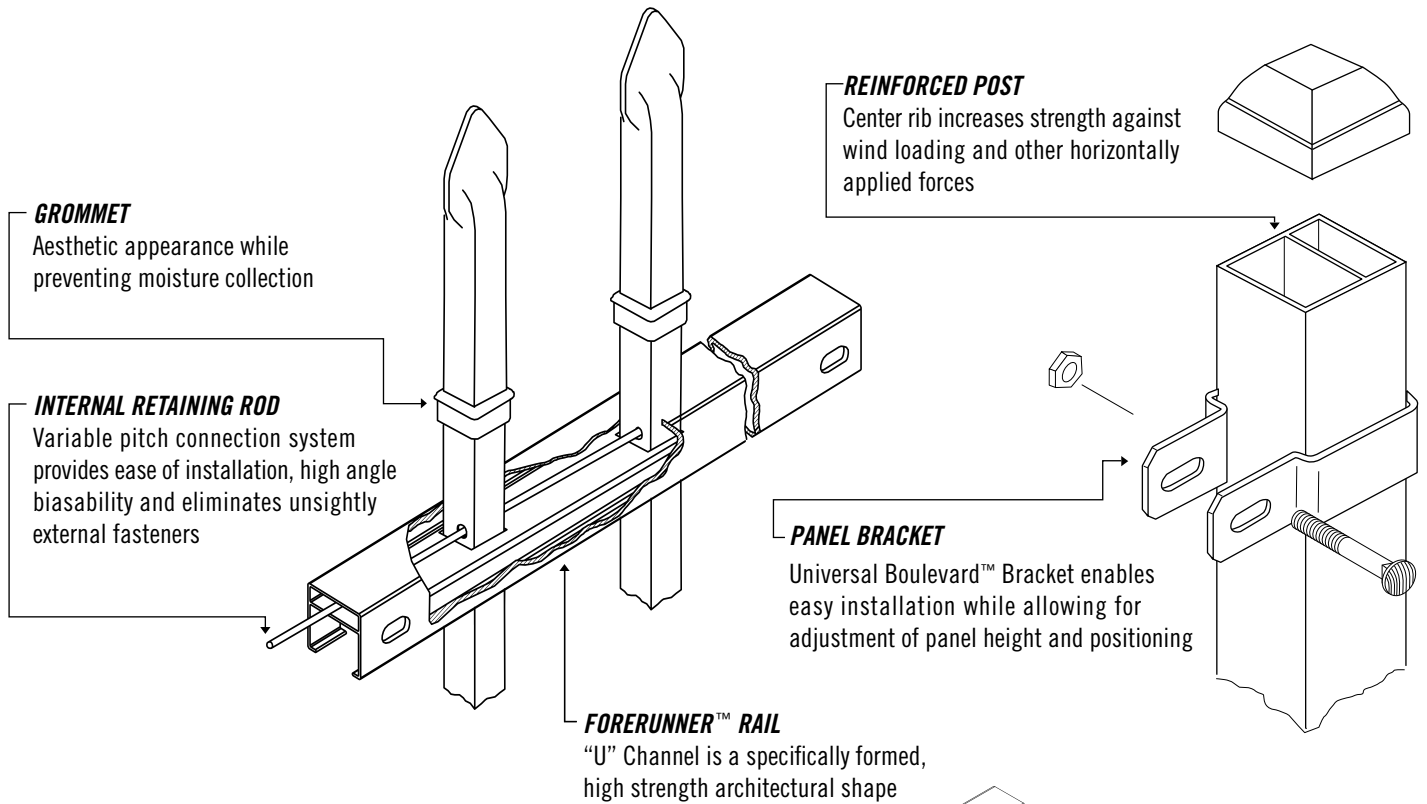

## ➤ INCREASED SECURITY

The ForeRunner Rail with internal retaining rod prevents the attachment from being compromised. Fasteners are not exposed

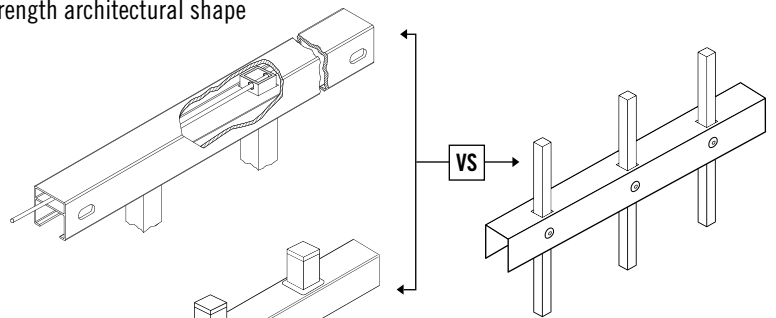

## ➤ AESTHETIC DETAILS

“Good Neighbor Design” rod follows ForeRunner centerline providing a clean and uninterrupted look, void of visible screws or rivets

## ➤ HIGH FUNCTIONALITY

Biasability at a minimum of 12.5% that requires no additional assembly

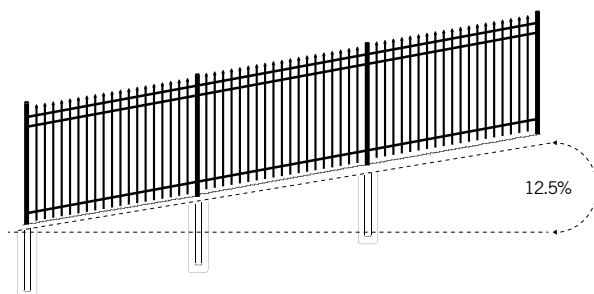



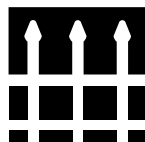

## **CLASSIC™**

Echelon Plus Classic style boasts *traditional extended pickets* with an arrow-shaped spear. These pointed pickets act as a *visual warning to potential intruders*.

- *3 Rail / 4 Rail options available*
- *Flush or Standard bottom options available*



## **MAJESTIC™**

Echelon Plus Majestic has a *contemporary feel* that incorporates a *flush top rail* which produces a stately and streamlined appearance. This fence style *highlights the landscape* by blending with the surrounding architectural design.

- *3 Rail / 4 Rail options available*
- *Flush or Standard bottom options available*

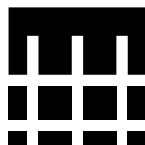

## **GENESIS™**

Echelon Plus Genesis has *sleek lines* of unaltered square pickets that are *reminiscent of solid vertical bar wrought iron*. The extended flat-topped tips can also be accented with decorative finials to enhance the fence design.

- *3 Rail / 4 Rail options available*
- *Flush or Standard bottom options available*

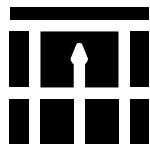

**CONQUEROR™**

Echelon Plus Conqueror marries *the best of classic style* with modern design. The spear tipped tops mingle below the *clean line of a straight rail*.

- *3 Rail / 4 Rail options available*
- *Flush or Standard bottom options available*

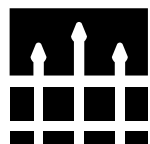

**WARRIOR™**

Echelon Plus Warrior adds *complexity and elegance* with *alternating picket heights*, bringing a higher level of sophistication to any fence system.

- *3 Rail / 4 Rail options available*
- *Flush or Standard bottom options available*

**ADORNMENTS**



QUAD FLARE



TRIAD



ROYALTY



RING

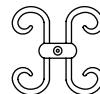

BUTTERFLY  
SCROLL



FLORENTINE  
SCROLL



BALL CAP

**COLORS**



BLACK



BRONZE



WHITE

## PUPPY PANELS

In many cases, particularly in relation to **safety or containment of small pets**, a narrower space between pickets may be necessary. Echelon Plus Puppy Panels **reduce the space between pickets** to less than 2" up to a height of 2' above ground.

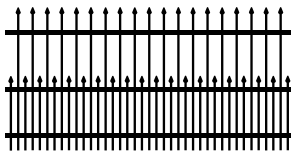

**CLASSIC™**

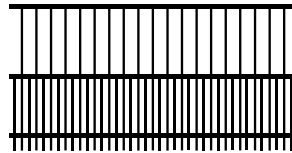

**MAJESTIC™**

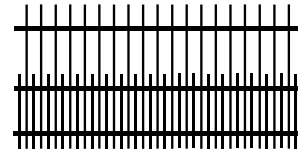

**GENESIS™**



### **POWDER COATED SUPERIOR FINISH**

Echelon features a state of the art polyester powder coating system that provides a durable and scratch resistant finish. This eco-friendly process provides years of long-lasting durability and maintenance-free ownership.



### **LIFETIME LIMITED WARRANTY**

The Echelon families of aluminum fencing products are manufactured from superior quality materials by skilled craftsmen with the highest standards of workmanship in the industry. Ameristar is confident in offering Echelon with a limited lifetime warranty, backed by over 30 years of demonstrated excellence in manufacturing of ornamental fence.



### **DOMESTIC MANUFACTURING**

Ameristar is committed to providing products that are manufactured in the USA. We have made significant investments in technology, process improvement, and employee training in an effort to secure American jobs and combat inferior import products.



## GATE SYSTEMS

Echelon Plus gate options vary from swing gates for pedestrian or vehicle entry to sliding entry gates for high functioning points of entry. Each of these gate systems are individually constructed with the highest level of craftsmanship to provide project specific performance.



# WHY CHOOSE AMERISTAR?

## ➤ **KNOWLEDGE & EXPERIENCE**

Ameristar was chartered over 30 years ago in response to the demand by consumers and specifiers for specialty fence products. Ameristar offers an aesthetically pleasing product that is both high in quality and affordability. This has been achieved by maximizing high-volume productivity, increasing product design strength, and promoting simplistic installation.

## ➤ **PROVEN CAPABILITY**

Ameristar's integrated in-house process and extensive raw material inventory results in much improved productivity and availability compared to the competition. By having a vast finished goods inventory, Ameristar is capable of delivering finished products faster than competitors who sublet the majority of their operations.

## ➤ **INDUSTRY LEADERSHIP**

Over the years Ameristar has continually raised the bar across the board in the manufacturing of high quality, innovative fencing products. Our demonstrated commitment to upholding higher values translates into superior products that go far beyond merely meeting minimum industry standards.



Ameristar's world headquarters, manufacturing & coil processing facilities in Tulsa, Oklahoma, USA.

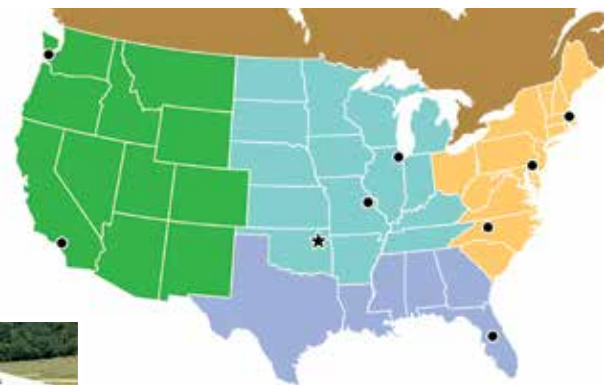

### LEGEND

- ★ Ameristar Headquarters
- Sales & Service Centers

Part #9729 | Revised 10/2018



[AMERISTARFENCE.COM](http://AMERISTARFENCE.COM) | 888-333-3422

ASSA ABLOY, the global leader in door opening solutions

**AMERISTAR®**

**ASSA ABLOY**